



OWNER'S MANUAL

# TREK3



TEAMBM PRO.COM





# BM PRO

## POWERING YOUR ADVENTURES

With over 50 years' experience in power solutions combined with manufacturing and design facilities in Melbourne, Australia, BM PRO are the leading experts in RV power and control management.

Inspired by the great outdoors, we have created a range of rugged, smart and reliable products to power your adventures.

Our range of battery, power and RV management control systems gives you peace of mind when you are on the road, so that you can relax in even the most far flung destinations, knowing you have control over your power needs.

To learn more about the BM PRO range of products, please visit our website [teambmpro.com](http://teambmpro.com)



# SAFETY PRECAUTIONS

Please read the Safety Precautions before installing or using the **Trek3**. Be sure to observe all precautions without fail. Failure to observe these instructions properly may result in personal damage, or personal injury which depending on the circumstances may be serious and cause loss of life.



Correct installation is the most critical factor in ensuring the safe use of the **Trek3**. If every consideration of these instructions has been satisfied, the **Trek3** will be safe to operate.



Keep the **Trek3** away from water or other liquids.



Clean the housing of this product lightly with a dry or moist cotton cloth. Do not use alcohol, thinners, benzene or any other chemical cleaner. Do not allow any liquids to enter the housing.



The **Trek3** is a high precision electronic product. It contains no user-serviceable parts inside. Do not try to dismantle, modify or repair it yourself. Disassembly, service or repair by an unauthorised person will void the warranty.



Product specifications are subject to change and improve without notice.



# CONTENTS

<b>SAFETY PRECAUTIONS</b> . . . . .	<b>4</b>
<b>ABOUT THE TREK3</b> . . . . .	<b>7</b>
OPTIONAL ADD-ONS . . . . .	7
<b>DESCRIPTION OF PARTS</b> . . . . .	<b>8</b>
<b>MOUNTING THE TREK3</b> . . . . .	<b>11</b>
<b>USING YOUR TREK3</b> . . . . .	<b>12</b>
TREK3 SET-UP MODE . . . . .	13
CLOCK MENU FUNCTION . . . . .	15
WATER TANK MENU FUNCTION . . . . .	16
CONFIGURING BATTERY CAPACITY. . . . .	17
CONFIGURING BATTERY ALARM . . . . .	17
LCD BACKLIGHT . . . . .	17
FACTORY RESET . . . . .	18
<b>SERVICING</b> . . . . .	<b>18</b>
<b>FAQS AND TROUBLESHOOTING</b> . . . . .	<b>19</b>
<b>APPENDICES</b> . . . . .	<b>20</b>
ADVANCED MENU FUNCTIONS . . . . .	20
<b>SPECIFICATIONS</b> . . . . .	<b>21</b>
<b>COMPLIANCE</b> . . . . .	<b>22</b>
<b>WARRANTY TERMS AND CONDITIONS</b> . . . . .	<b>23</b>

**MANUAL PART 035490**  
REV 1.0



Designed by BM PRO, one of Australia's leading power solution experts, the BM PRO product range is proudly designed and manufactured in Melbourne, Australia, and represent a high-quality product that will provide years of service.

**DISCLAIMER** BM PRO accepts no liability for any loss or damage which may occur from the improper or unsafe use of its products. Warranty is only valid if the unit has not been modified or misused by the customer.

## ABOUT THE TREK3

The **Trek3** is a wall-mounted smart battery monitor designed specifically to operate with BMPRO's **BatteryPlus35**.

The **Trek3** provides vital data at a glance including caravan battery voltage and charging/discharging current. The **Trek3** also provides an indication of the battery's remaining charge capacity as well as the time remaining before the battery completely discharges - so you'll never be left on the road without battery power.

In addition to battery monitoring, the **Trek3** enables monitoring of water levels of up to four water tanks and control of two water pumps, all from a sleek, wall mounted display.

The **Trek3** can be connected to the included **OdysseyLink103** to become part of the Odyssey system. Once connected to the **OdysseyLink103**, you can use BMPRO's free Odyssey App to remotely monitor your battery and control your caravan's water pumps from your smartphone!

For more information about Odyssey, refer to your Odyssey Owner's Manual.

### OPTIONAL ADD-ONS

To get the most out of your **Trek3**, it may be used with the following products from the BMPRO range:

-  **Dipper** water level indicator

# DESCRIPTION OF PARTS



Figure 1: The Trek3 Monitor

## 1 BATTERY

Displays the charging/discharging current and voltage of the caravan battery connected to the **BatteryPlus35**.

The Battery display will flash if BM PRO's **BC300 External Shunt + CommLink** has been installed and communication with the **BC300** is lost.

## 2 BATTERY CAPACITY BAR GRAPH

Displays an estimate of the capacity of the connected battery, and underneath indicates if the battery is 'CHARGING' or 'DISCHARGING'.

## 3 AC CONNECTED

Appears when the **BatteryPlus35** is connected to AC mains.

## 4 BATTERY LOW

Appears when the battery voltage falls below the low voltage warning threshold and indicates that the battery requires charging.

By default, the low voltage warning threshold is 11V for lead acid batteries and 12.3V for LiFePO<sub>4</sub> batteries and can be configured by the user.



## 5 BATTERY OFF

Battery Off will appear when:

1. The user presses the battery button 6 to enter ECO mode.
2. The **BatteryPlus35** has automatically entered ECO mode to preserve battery capacity until the battery can be charged.

To reduce current draw from the battery, all other display segments on the **Trek3** will turn off as well.

## 6 BATTERY BUTTON

Enables ECO mode which powers off all caravan loads connected to the **BatteryPlus35** load terminal block, except for terminal 1. Battery charging is not affected by ECO mode.

As the caravan is no longer powered, ECO mode is a convenient way to save remaining battery power if you are on the road and have limited ability to charge the battery.

When charging, ECO mode ensures that all available charging current is dedicated to charging your battery.

In Set-Up mode, the Battery button acts as the EDIT function.

## 7 HOME BUTTON

To enter Set-Up mode on the **Trek3** and configure user settings. In Set-Up mode, the Home button acts as the BACK function.

## 8 BACKLIGHT BUTTON

To turn the backlight/nightlight of the **Trek3** screen on and off.

A single press of the Backlight button will turn the backlight on. Press again to turn the backlight off; otherwise the backlight will automatically turn off after 30 seconds.

To turn the nightlight on, press and hold the Backlight button for three seconds or until the backlight blinks. The nightlight will stay on for 10 hours. To turn nightlight off, press and hold the Backlight button until the nightlight turns off.

In Set-Up mode, the Backlight button acts as the UP-scroll arrow function.

## 9 WATER PUMP BUTTON

To turn the water pumps connected to the **BatteryPlus35** on and off. When the **BatteryPlus35** and **Trek3** are first powered on, both pumps will be turned on as well.

To turn pump 1 on/off, press the Water Pump button once.

To turn pump 2 on/off, press and hold the Water Pump button until the desired change is seen.

In Set-Up mode, the Water Pump button acts as the DOWN-scroll arrow function.

## 10 TIME REMAINING

Indicates the estimate time remaining until the battery is completely discharged.

Time remaining less than 180 minutes will be displayed in MINS. Time remaining greater than 180 minutes will be displayed in HRS.

## 11 INPUT AMPS

Displays the current drawn by the **BatteryPlus35** from its auxiliary and solar inputs to power loads and charge the caravan battery.

If either of the inputs are unavailable to the **BatteryPlus35**, the **Trek3** will display "--.-".

If either of the inputs are available to the **BatteryPlus35** but not in use, the **Trek3** will display "00.0".

## 12 WATER PUMP STATUS

Indicates if the pumps connected to the **BatteryPlus35** are turned ON or OFF.

## 13 TANK LEVEL INDICATORS

Monitor water tank levels of up to 4 water tanks.

By default, tanks 1 and 2 are set-up to monitor clean water tanks and tanks 3 and 4 to monitor dirty water tanks. Tank properties are configurable in Set-Up mode.

The tank level indicator will flash when the monitored tank is empty (clean water) or full (dirty water). If a tank is not monitored, the indicator will be blank.

# MOUNTING THE TREK3

The **Trek3** is designed to be mounted to the wall directly with screws. A hole for the connectors must be drilled before mounting.

Flat head screws with a maximum diameter of 4.0mm must be used for mounting.

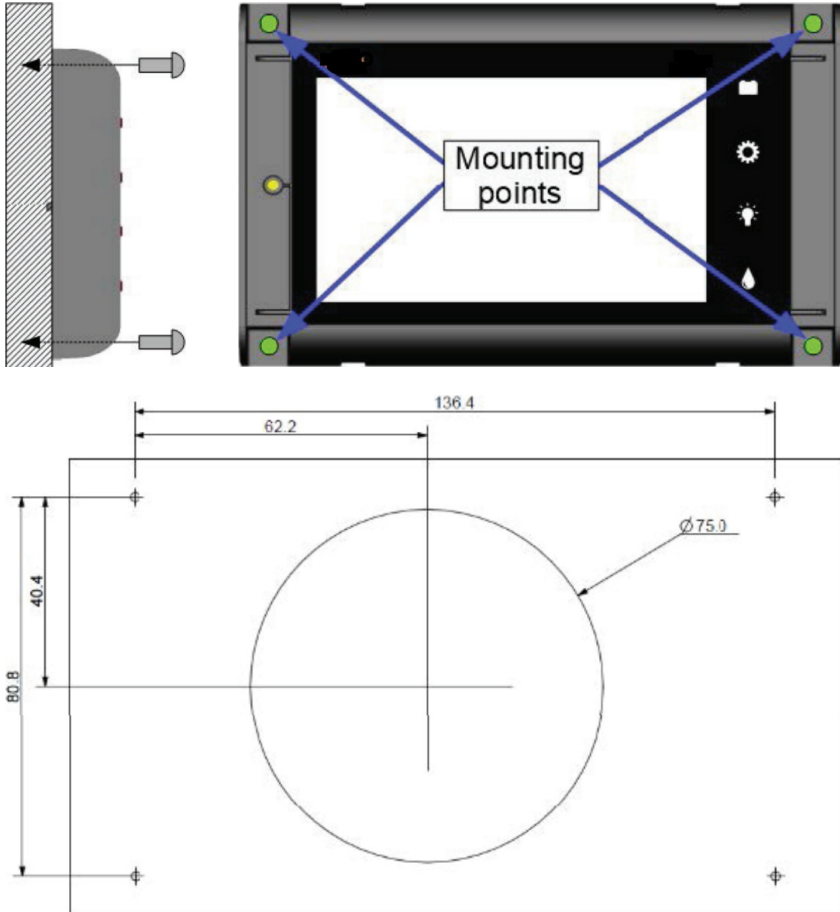

Figure 2: Trek3 mounting method details

After fixing the **Trek3** to the wall, make all connections at the rear of the **Trek3**.

Once all connections are made, clip on the provided fascia cover to the **Trek3**.

# USING YOUR TREK3

The **Trek3** does not have an ON/OFF button. The **Trek3** receives power directly from the **BatteryPlus35** through the connected data cable. The **Trek3** will automatically turn off if it is not receiving power from the **BatteryPlus35**.

Upon start-up, the **Trek3** will display **Can Err** on its Home screen, until communication between the **Trek3** and **BatteryPlus35** is established.

Once communication is established, the **Trek3** will display the relevant battery and system information on its screen.

If the **Trek3** cannot establish communication to the **BatteryPlus35**, the **Trek3** will display **Can Error**.

Please check the data cable between the **Trek3** and **BatteryPlus35**.

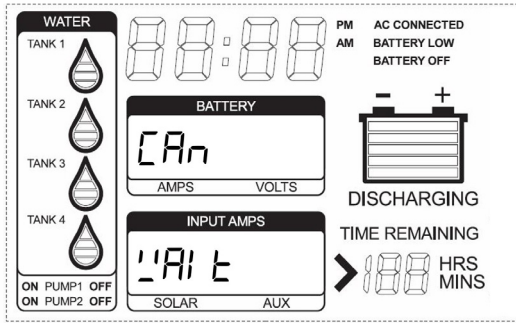

Figure 3: The Trek3 start-up screen

## TREK3 SET-UP MODE

### ENTERING SET-UP MODE

The **Trek3** Set-Up mode allows you to access the functions to configure the **Trek3** display, enter important battery information, set alarms and configure tanks.

To enter Set-Up mode, hold the HOME button down until *SEt UP* is seen on the Battery display.

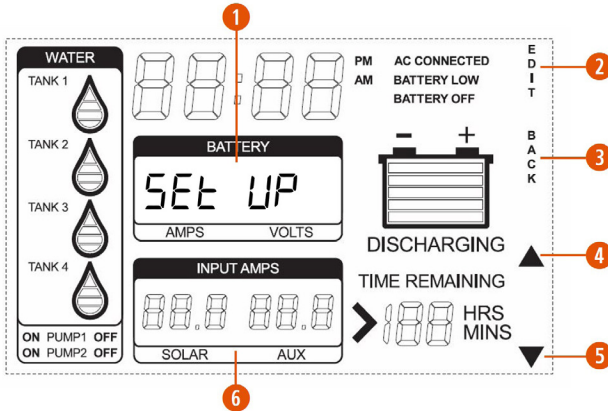

Figure 4: Trek3 Set-Up Mode

The **Trek3** Set-Up screen includes:

#### 1 6 MENU FUNCTION DISPLAY

Displays the various Set-Up menu functions that can be accessed in Set-Up mode **1** and any associated information **6**. If the function can be edited, the menu function will flash on screen.

#### 2 EDIT

Use the Battery button on the **Trek3** to select a menu function or sub-function to edit.

#### 3 BACK

Use the Home button on the **Trek3** to return to the previous 'Screen' or menu function. Repeatedly press the Home button to return to the **Trek3** home screen.

#### 4 5 SCROLL ARROWS

Use the Backlight and Water Pump buttons on the **Trek3** to navigate the Set-Up menu and change values when configuring the **Trek3**.

## EXITING SET-UP MODE

To exit Set-Up mode or to exit from any menu function available in Set-Up mode, repeatedly press the BACK button until the **Trek3** enters the Home screen.

Alternatively, wait and the **Trek3** will automatically revert to the Home screen, saving any changes made when editing the menu functions.

## SET-UP MODE MENU FUNCTIONS

Table 1 lists all the menu functions available to the user from Set-Up mode. When in Set-Up mode, use the up and down scroll arrows to navigate the Set-Up menu functions.

**Table 1:** **Trek3** Set-Up menu functions

<i>CLDCH</i>	Set time on the <b>Trek3</b> display
<i>ERnHS</i>	Configure the water tanks
<i>bRECAP</i>	Configure the battery capacity of the battery connected to the <b>BatteryPlus35</b>
<i>bREALT</i>	Adjust low voltage warning thresholds for the low battery alarm
<i>bHLI L</i>	Adjust the LCD backlight
<i>AduAnC</i>	Advanced menu settings. For technical personnel only. The functions available in the Advanced menu setting may vary with some versions of the <b>BatteryPlus35</b> .
<i>SQLS'</i>	Displays the solar software version, available only when solar source is present
<i>SQHL'</i>	Displays the solar hardware version, available only when solar source is present
<i>bP35 S'</i>	Displays the <b>BatteryPlus35</b> software version
<i>bP35 H'</i>	Displays the <b>BatteryPlus35</b> hardware version
<i>Er2S'</i>	Displays the <b>Trek3</b> software version
<i>Er2H'</i>	Displays the <b>Trek3</b> hardware version
<i>FREErY</i>	To perform a factory reset

## CLOCK MENU FUNCTION

Time may be set in either 12- or 24-hour formats.

### 12-Hour Format

Enter Set-Up mode and navigate to the *CLOCK* menu function. Follow the directions in figure 4 to set the time in 12-hour format on the **Trek3** display.

The AM and PM annunciators will automatically change as the hour changes from 11 to 12.

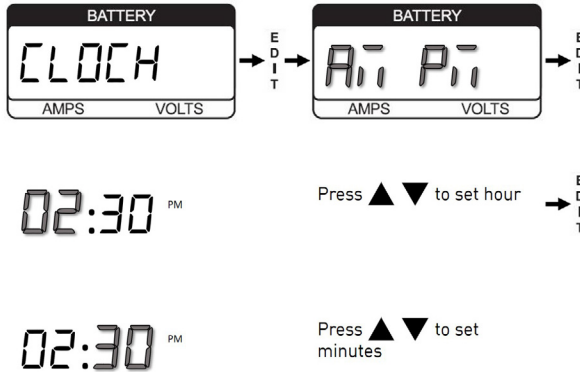

Figure 5: Setting 12-hour time format on the **Trek3** display

### 24-Hour Format

Enter Set-Up mode and navigate to the *CLOCK* menu function. Follow the directions in Figure 5 to set the time in 24-hour format on the **Trek3** display.

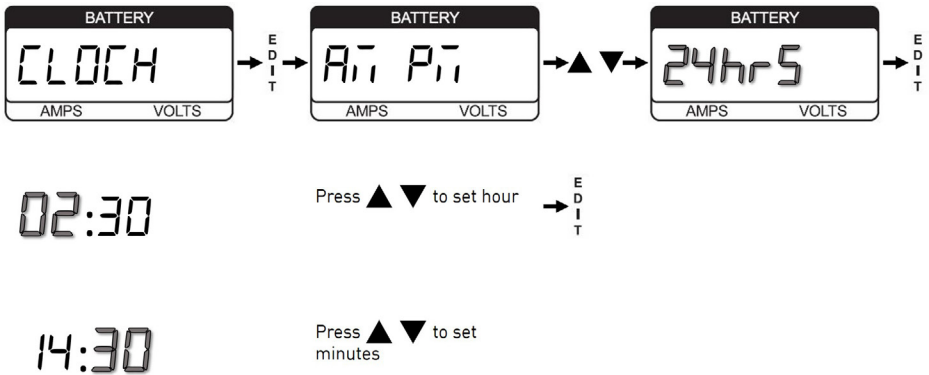

Figure 6: Setting 24-hour time format on the **Trek3** display

## WATER TANK MENU FUNCTION

Use the Water Tank menu function to choose to monitor and display (enable on/disable off) a water tank and configure the water tank type (clean/dirty).

### Enable and Disable Water Tank Monitoring and Display

Enter Set-Up mode and navigate to the *tAnHS* menu function. Follow the directions in figure 6 to enable or disable the monitoring and display of a water tank with the **Trek3**.

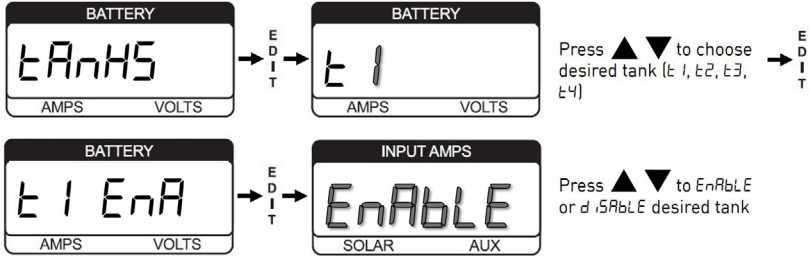

Figure 7: Enabling and disabling a water tank for monitoring and display with the **Trek3**

### Configure Water Tank Type

Enter Set-Up mode and navigate to the *tAnHS* menu function. Follow the directions in Figure 7 to configure the water tank type. The ability to configure a water tank type is only available if monitoring of the tank is enabled.

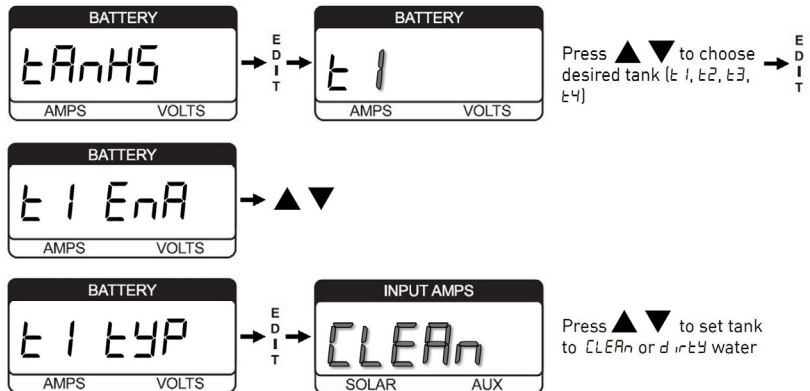

Figure 8: Configuring the water tank type



## CONFIGURING BATTERY CAPACITY

The battery capacity needs to be set whenever a new battery is fitted to the **BatteryPlus35**. By default, the battery capacity is set to 100AH.

Correctly configuring the battery capacity ensures that the **BatteryPlus35** will select the best charging parameters for the caravan battery in use and the software accurately estimates battery usage including Battery Capacity and Time Remaining.

Enter Set-Up mode and navigate to the *bAtCAP* menu function. Follow the directions in Figure 8 to configure the battery capacity. The battery capacity can be adjusted between 50 and 600AH in steps of 10AH.

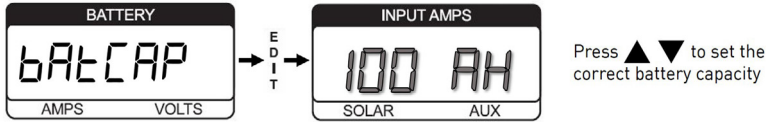

Figure 9: Configuring the battery capacity

## CONFIGURING BATTERY ALARM

Configure the battery alarm and set the low battery voltage warning threshold to trigger the Battery Low warning on the **Trek3** Home screen to indicate that the battery requires charging.

By default, the low voltage warning threshold is 11V for lead acid batteries and 12.3V for LiFePO<sub>4</sub> batteries.

Enter Set-Up mode and navigate to the *bAtALi* menu function. Follow the directions in Figure 9 to configure the battery alarm. The battery alarm can be adjusted between 10.0 and 14.0V in steps of 0.5V.

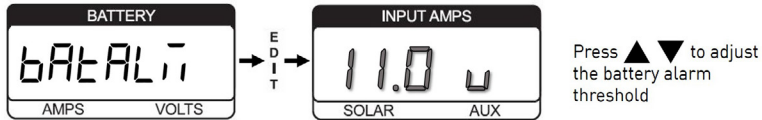

Figure 10: Configuring the battery alarm

## LCD BACKLIGHT

Use the LCD Backlight function to change the brightness level of the **Trek3's** LCD backlight.

Enter Set-Up mode and navigate to the *bAHLi* menu function. Follow the directions in Figure 10 to configure the backlight brightness. The brightness can be adjusted between 0 and 100% in steps of 10%.

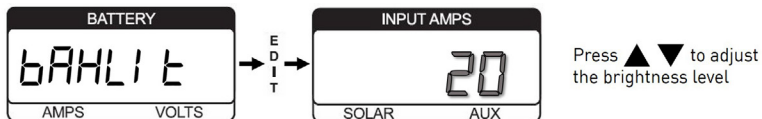

Figure 11: Configuring the LCD backlight brightness level

## FACTORY RESET

Enter Set-Up mode and navigate to the *FACTORY* menu function. Follow the directions in Figure 11 to perform a factory reset and restore the **Trek3** to the factory settings.

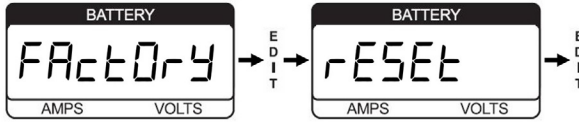

Figure 12: Factory reset

## SERVICING

Do not attempt to service the **Trek3** yourself, OR dismantle, modify or repair the **Trek3** yourself; this will void your warranty. If your **Trek3** requires servicing, please consult your BMPRO dealer or visit [teambmp.com](http://teambmp.com) for assistance.

# FAQS AND TROUBLESHOOTING

## Need more help troubleshooting your Trek3?

Contact our customer service team online at [teambmp.com/technical-support](https://teambmp.com/technical-support)

## Why has the Trek3 screen turned off?

The **Trek3** receives power to run the monitor from the **BatteryPlus35**. If the **BatteryPlus35** shuts power to the monitor, the **Trek3** screen will turn off. The **BatteryPlus35** will shut power to the **Trek3** if:

1. The user activated the load isolation switch connected to the **BatteryPlus35**. This turns off power to the data cable connecting the **Trek3** and **BatteryPlus35**. Check that the switch has not been activated.
2. The **BatteryPlus35** has entered Storage Mode and to conserve remaining battery voltage will disable power to the **Trek3**.  
To re-power the **Trek3**, plug the **BatteryPlus35** to a power source and begin battery charging. When the battery is sufficiently charged, the **BatteryPlus35** will enable power to the **Trek3**.

## Why are the battery volts and amp flashing on the Trek3?

Battery volts and amps will flash on the **Trek3** if a **BC300 + CommLink** external shunt has been installed and communication with the shunt has been lost.

Use the advanced menu function *ESHUNT* to clear the external shunt from memory and re-establish communication with the **BC300 + CommLink**. See the **Appendices** for more details.

## I have water tanks, but they are not showing up on my Trek3?

If your **Trek3** is connected to the **OdysseyLink103**, then the water tanks also need to be connected to the **OdysseyLink103** for them to show up.

# APPENDICES

## ADVANCED MENU FUNCTIONS

### Configure Battery Chemistry

The ability to configure battery chemistry is available only if the **Trek3** is in use with the **BatteryPlus35-HA** which is capable of charging both lead acid and  $\text{LiFePO}_4$  type batteries.

By default, the **BatteryPlus35-HA** is configured to charge lead acid batteries. This can be changed with the **Trek3** monitor.

To configure the **BatteryPlus35-HA** to charge  $\text{LiFePO}_4$  batteries with the **Trek3** monitor, enter Set-Up mode, select the *AdvanC* menu function and navigate to the *bAtChn* menu function. Then follow the directions in figure 12.

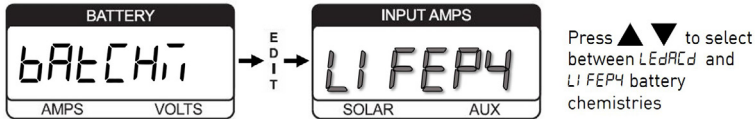

Figure 13: Configuring battery chemistry

### Clear External Shunt

This function is only available if the **BC300 + CommLink** external shunt is installed on the caravan battery. This menu item should be used when communication with the external shunt is lost. See **FAQs and Troubleshooting** for more details.

To clear an external shunt, enter Set-Up mode, select the *AdvanC* menu function and navigate to the *EShUnt* menu function. Follow the directions in Figure 13.

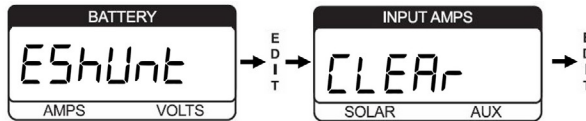

Figure 14: Clearing the external shunt

## Adjusting Bulk Voltage

The bulk voltage is the maximum voltage at which the **BatteryPlus35** will charge the battery. The bulk voltage may be adjusted from 13.6 to 14.8V in steps of 0.1V.

### WARNING

Changing the bulk voltage may result in the battery overcharging and cause damage to the battery and in extreme cases may also cause personal harm.

If unsure **DO NOT** change the default values.

To adjust bulk voltage, enter Set-Up mode, select the *AdUAnC* menu function and navigate to the *CHARGE* menu function. Follow the directions in Figure 14.

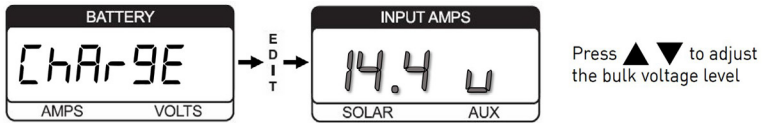

Figure 15: Adjusting bulk voltage

## SPECIFICATIONS

Trek3	
Input Voltage Range	8-15V
Battery Drain	< 21mA with backlight off
Ambient Temperature	0-50°C
Dimensions (mm)	164W x 108H x 22D

# COMPLIANCE

This equipment has been tested and found to comply with the limits for a Class B digital device, pursuant to Part 15 of the FCC Rules. These limits are designed to provide reasonable protection against harmful interference in a residential installation. This equipment generates, uses and can radiate radio frequency energy and, if not installed and used in accordance with the instructions, may cause harmful interference to radio communications. However, there is no guarantee that interference will not occur in a particular installation. If this equipment does cause harmful interference to radio or television reception, which can be determined by turning the equipment off and on, the user is encouraged to try to correct the interference by one or more of the following measures:

- Reorient or relocate the receiving antenna,
- Increase the separation between the equipment and receiver,
- Connect the equipment into an outlet on a circuit different from that to which the receiver is connected,
- Consult the dealer or an experienced radio/TV technician for help.

Warning: Any changes or modifications not expressly approved by BMPRO could void the user's authority to operate this equipment.

This device complies with part 15 of the FCC Rules. Operation is subject to the following two conditions: (1) This device may not cause harmful interference, and (2) this device must accept any interference received, including interference that may cause undesired operation.

# WARRANTY TERMS AND CONDITIONS

Registering your BMPRO product is an important step to ensure that you receive all the benefits you are entitled to. Please visit [teambmp.com](https://teambmp.com) to complete the online registration form for your new product today.

1. BMPRO goods come with guarantees that cannot be excluded under Australian Consumer Law. You are entitled to a replacement or refund for major failure and for compensation for any reasonably foreseeable loss or damage. You are entitled to have the goods repaired or replaced if the goods fail to be of acceptable quality and the failure does not amount to a major failure. The benefits under this Warranty are in addition to your other rights and remedies under a law in relation to the goods to which this Warranty relates (the Australian Consumer Law).
2. BMPRO warrants products against defects for a period of two years, commencing from the original date of purchase. Proof of purchase is required before you can make a claim under this warranty.

## HOW TO PROTECT YOUR RIGHTS UNDER THIS WARRANTY

3. The **Trek3** is designed to be installed by a suitably qualified installer. You or your installer should carefully inspect the products before installation for any visible manufacturing defects. We accept no responsibility in addition to our consumer guarantee obligations where a product has been installed incorrectly.
4. This warranty does not extend to product failures or defects caused by, or associated with, but not limited to: failure to install or maintain correctly, unsuitable physical or operating environment, accident, acts of God, hazard, misuse, unauthorised repair, modification or alteration, natural disaster, corrosive environment, insect or vermin infestation and failure to comply with any additional instructions supplied with the product.
5. BMPRO may seek reimbursement of any costs incurred by BMPRO when a product is found to be in proper working order or damaged as a result of any of the warranty exclusions mentioned in point 4 of this statement.
6. To enquire or make a claim under this warranty, please follow these steps:
  - a. Prior to returning a BMPRO product, please email [customerservice@teambmp.com](mailto:customerservice@teambmp.com) to obtain a Return Material Authorisation (RMA) number
  - b. Package and send the product to:  
**BMPRO Warranty Department**  
**19 Henderson Road**  
**Knoxfield, VIC 3180**  
Please mark RMA details on the outside of the packaging
  - c. Please ensure the package also includes: a copy of the proof of purchase, a detailed description of the fault and your contact details including phone number and return address.
7. BMPRO will not be liable for any costs, charges or expenses incurred in the process of returning a product in order to initiate a warranty claim.

**POWERING YOUR ADVENTURES.**



**TEAM  
BM PRO  
.COM**

**BM PRO**  
sales@teambmpro.com  
19 Henderson Rd, Knoxfield VIC 3180 Australia  
teambmpro.com