

THETFORD

Build-in cooking hob

**Topline hybrid glass hobs
SHB981XXZ Series dual fuel**

For use with mains electricity and Universal LPG

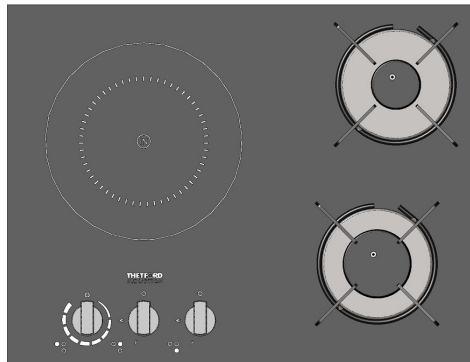

User and installation instructions

Please read and keep for future reference

For use in Australia

**THETFORD AUSTRALIA PTY LTD
41 LARA WAY CAMPBELLFIELD VIC
TEL: 03 9358 0700 FAX: 03 9357 7060**

www.thetford-europe.com

INS1021Z -0-



CAUTION



- Appliance and accessible parts become hot during use. Avoid touching the heating elements or pan supports when in use.
- The use of a gas cooking appliance results in the production of heat, moisture and products of combustion in the room in which it is installed. Ensure that the kitchen is well ventilated especially when the appliance is in use. Keep natural ventilation holes open or install a mechanical ventilation device (mechanical extractor hood).
- Prolonged intensive use of the appliance may call for additional ventilation by opening of a window or more effective ventilation by increasing the level of mechanical ventilation where present.
- Do not use or store flammable materials in the appliance storage drawer or near this appliance.
- Do not spray aerosols in the vicinity of this appliance whilst it is in operation.
- This appliance is not intended for use by persons (including children) with reduced physical, sensory or mental capabilities or lack of experience or knowledge, unless they have been given supervision or instruction by a person responsible for their safety.
- Children less than 8 years of age shall be kept away unless continuously supervised.
- Children shall not be permitted to play with the appliance.
- Cleaning and user maintenance shall not be made by children without supervision.
- Unattended cooking on a hob with fat or oil can be dangerous and may result in fire. Do not leave the appliance unattended when in use.
- Never extinguish a cooking fire with water, switch off the appliance and cover the flames with a lid or fire blanket.
- Danger of Fire: Do not store items on the cooking surface.
- The use of inappropriate hob guards can cause accidents and may affect safe combustion of the appliance.



CAUTION



- Do not modify this appliance. Do not make any adjustments unless such work is carried out by authorized personnel, the manufacturer or their representative. No parts other than those supplied by the manufacturer shall be used on this appliance.
- Do not allow cooking vessels to overlap the edges of the appliance – use the correct sizes of pans and position them centrally over the burners.
- Do not use harsh abrasive cleaners or sharp metal scrapers to clean the glass since they can scratch the surface, which may result in shattering of the glass.
- Do not use steam cleaners or pressure washers to clean the appliance. Refer to cleaning and maintenance instructions.
- This appliance is for cooking purposes only. Where this appliance is installed in marine craft or in caravans, it shall not be used as a space heater.
- This appliance is not intended to be operated by means of an external timer or separate remote-control system.
- Do not allow oils, fats or food residues to build up on the appliance – clean the appliance after each use.
- If the supply cord becomes damaged it must be replaced by the manufacturer or agent in order to avoid a hazard.
- Do not heat sealed tins of food, they could explode.
- Do not leave empty pans on a heating zone.
- Do not use kitchen foil on any part of the hob, it can melt and cause damage to the hob surface.
- If the glass surface becomes cracked, switch off and disconnect the appliance from the electrical supply to avoid the possibility of electric shock and contact your Service Agent.
- Metal objects such as knives, forks, spoons and lids must not be placed on the hob surface since they can become very hot.
- This appliance must be earthed.

INTRODUCTION

This appliance is designed for cooking foods and any other use is incorrect and may be dangerous. Failure to install the appliance correctly or improper use will invalidate any warranty or liability claims.

This appliance must only be installed by a qualified installer or engineer in accordance with the relevant local and national regulations in force. Failure to install the appliance correctly could invalidate any warranty or liability claims and lead to prosecution. Please refer to the methods of installation and use supplied with this appliance.

Our policy is one of continuous development and improvement. Specifications and illustrations may change without notice, subsequent to publication.

Provision of ventilation

The use of a gas cooking appliance results in the production of heat, moisture and products of combustion in the room in which it is installed. Ensure that the area where the appliance is used is well ventilated especially, when the appliance is in use. Keep natural ventilation holes open or install a mechanical ventilation device (mechanical extractor hood).

Prolonged intensive use of the appliance may call for additional ventilation, for example opening of a window, or more effective ventilation, for example increasing the level of mechanical ventilation where present.

The room containing the cooker shall be ventilated in accordance with all local and national regulations in force.

Initial Cleaning

Before using the hob for the first time, check the power supply is switched off and use a dampened soft cloth to remove any soiling or residual factory lubricants. Once clean apply a thin coating of ceramic glass cleaner conditioner to the glass surface and polish with a clean dry cloth.

The conditioner provides a protective surface coating which will make cleaning the hob easier. Occasionally reapplying the conditioner will reduce the accumulation of deposits from cooking.

If the glass surface becomes discoloured due to cooking deposits, clean the glass using a mild cream cleaner or use a ceramic hob scraper. Wipe the surface clean and re-apply the cleaner conditioner. See Care and Maintenance section.

This appliance is approved for use with Universal LPG.

The burners on this appliance have fixed aeration and no adjustment is required. The burners should flame as follows;

ULPG: Normally on initial lighting, a small amount of yellow tipping will occur which increases slightly as the burner heats up.

OPERATION OF THE GAS BURNERS

The burners are controlled individually and each is monitored by a thermocouple probe. In the event the burner flames are accidentally extinguished, turn off the burner control and do not attempt to re-ignite the burner for at least one minute.

1. Ensure gas and electric supply is connected and turned on.
2. Push in the control knob and turn anticlockwise to full rate – large flame (🔥), see Fig 1.
3. Continue depressing the knob whilst holding a lighted match or taper to the burner.
For models fitted with 'Auto-Spark' the procedure is similar except burner ignition is automatic whilst the knob is depressed.
4. After the burner is lit continue depressing the knob for approximately 10 - 15 seconds.
5. Release the knob and turn it to the required heat setting.
6. If burner has not lit within 15 seconds, release knob and wait at least 1 minute before repeating operations (2) to (5).
7. To turn off, rotate the control knob until the line on the knob is aligned with the dot on the control panel.
8. Always make sure the control knobs are in the off positions when you have finished using the hotplate burners.

The gas burners will accept minimum pan sizes of Ø 100mm. A minimum gap of 10mm must be maintained between pans and the pans must not overlap the edges of the appliance.

Fig. 1 - Control Positions, Gas Burners

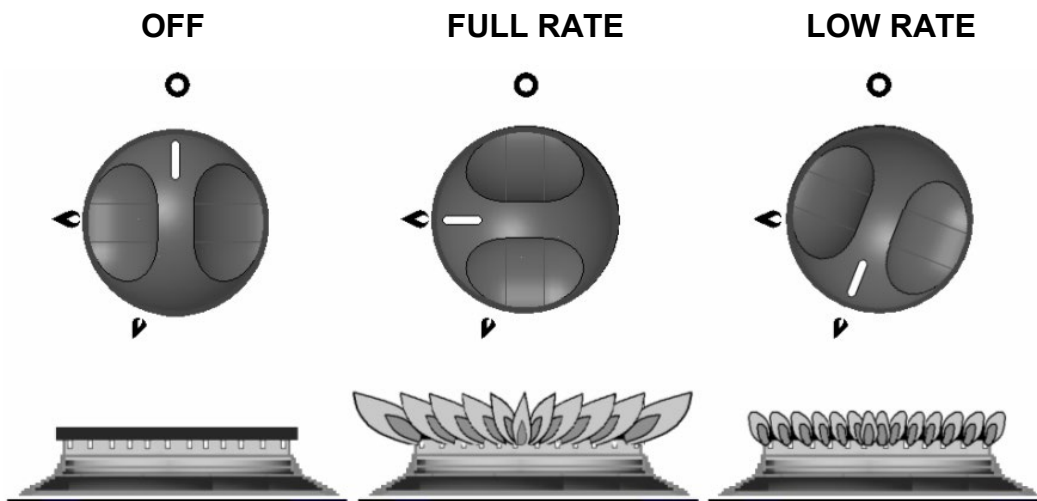



- Avoid old or miss-shaped pans as these may cause instability.
- Using excessively large pans may reduce performance or cause damage.

GLASS SYMBOL DESCRIPTIONS

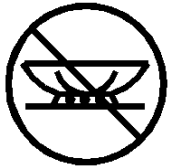

Do not remove the pan support and enclose the burner with a wok stand as this will concentrate and deflect heat onto the hotplate



Do not place anything, e.g. flame tamer, asbestos mat, between pan and pan support as serious damage to the appliance may result



Do not use large pots or heavy weights which can bend the pan support or deflect flame onto the hotplate

OPERATION OF THE INDUCTION HOB

Cooking on Induction

Cooking with an Induction Hob is different to a conventional hob which has either heating elements or hotplates. An induction hob uses powerful electro magnets which are located below the glass surface. When a pan manufactured from magnetic material is placed directly above an electro-magnet, energy is induced into the metal of the pan. This energy causes the metal pan to become hot and is sufficient to provide the heat for cooking. Since heat for cooking is created inside the pan, only the area of glass in direct contact with the pan will become very hot.

To ensure you achieve maximum cooking efficiency from your Induction hob we recommend the use of pans which are specifically made for this type of appliance. Choose pans which show a coil symbol and state 'Induction' on the underside. If however you wish to use your existing pans and are unsure if they are suitable, you can check if they are the correct type by using a magnet. If the magnet will attach to the base then the pan should be suitable for induction.

OPERATION OF THE INDUCTION HOB

The induction heating zone is marked with a circular dotted line with the symbol 'IN' at the centre.

Please ensure, regardless of pan type (stainless, enameled steel, cast iron, etc) the pan base is smooth and flat to avoid the risk of scratching the glass. Never slide the pan across the glass surface, lift the pan to avoid scratches.

We recommend pans with a base diameter of Ø135mm to Ø220mm for the induction heating zone.

Glass, ceramic or earthenware pans, aluminium (unless they have a special base), copper pans and some non-magnetic stainless steel pans are not suitable for use on Induction hobs.

Using the Induction Hob

The induction heating zone on the hob is controlled separately using the rotary control switch (Fig 2). An LED indicator illuminates when the induction hob is activated and when the hob is hot during or after use.

Fig. 2 – Induction Hob Controls, (with Separate Gas Controls shown).

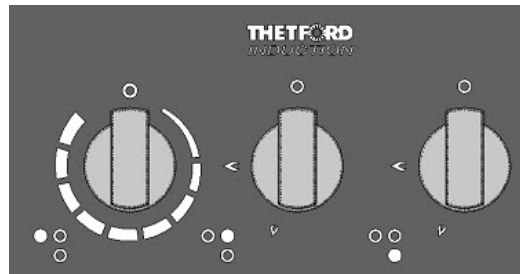

SHB981XX Series

Start Up: Upon initial connection to the mains electricity supply, the LED illuminates briefly with '8', then '0', then goes blank. As a safety feature, if the control knob is not in the '0' (Off) position on initial connection, the LED display will go blank. The induction unit cannot be operated until the control is reset to '0' and the LED will display '0' if the control is moved to any other position.

To reset the unit, rotate the control anticlockwise to the '0' position, the LED indicator then goes blank and the induction heater is ready for use.

The induction hob will accept a minimum pan size of Ø 100mm.

Switching On: Place a suitable pan containing food or water on the induction heating zone. The induction heater is switched on when the control knob is rotated clockwise from power level '0' position to any higher position. When the heater is activated the red LED light is illuminated to indicate the power setting from '1', lowest power, to '9' maximum power. A graduated display around the control knob also indicates the increasing power setting.

Selecting a Power Level: To select the desired power level for the heater, the control knob must be rotated to the corresponding position. The control may be moved clockwise to increase power and anti-clockwise to reduce power.

Switching Off the Heater: The heater is switched off when the control knob is turned anticlockwise to power level '0' position and the red LED light goes out.

Induction Control LED Display Functions:

U = Pan Detector – No pan detected or unsuitable pan.

H = Residual Heat Indicator – Hob surface is still hot.

L = Child Safety Lock – The appliance remains inoperative until unlocked.

0 or 1-9 = Power Setting – **0** = off, **1** = minimum up to **9** = maximum power.

A = Automatic Heat Up Function Active.

Heater without Pan or Unsuitable Pan: If an unsuitable pan is used or there is no pan on the induction heating zone when the heater is activated, the LED light displays **U**. After 30 seconds in this condition, if no suitable pan is placed on the induction zone, the heater is automatically switched off and the LED display will briefly display '0', then go blank indicating that the heater is not active. It is necessary to turn the control knob back to '0' position to re-set the system, before the heater can be activated again. **After use, always switch off the hob element by its control and do not rely on the pan detector.**

Power Setting: On power settings from 1 to 8, the induction unit pulses continuously from low to high power to provide efficient heating. On setting 9 the power of the induction heater remains at a high level.

Residual Heat: When the glass hob top is hot during cooking or after cooking has finished, residual heat is indicated by 'H' on the LED light whilst the hob surface temperature is above 60°C. Once cooled to below 60°C the LED light goes out.

Child Safety Lock: With the control set to '0', rotate the knob anti-clockwise and hold for approximately 5 seconds until 'L' is shown in the LED display. The induction heater then remains inoperative until the control is unlocked and 'L' remains displayed by the LED indicator. To unlock the induction heater, repeat the locking procedure until 'L' disappears from the display, then return the control to '0'.

Automatic Heat-up: This function allows rapid heat up of the induction zone, with automatic reduction to a preset level once the desired temperature is reached. To activate, with a suitable pan in position and the control set to '0', rotate the control knob anti-clockwise briefly until 'A' is shown in the LED display, then rotate the knob immediately clockwise to the desired pre-set power level. The LED indicator shows 'A' and the induction unit will operate on maximum power setting to bring the cooking zone up to temperature. The unit then automatically reduces the power to the pre-set level which is then displayed. The Automatic Heat-up function operates in accordance with the times shown in the table below.

Power Level	Auto Heat-up Time at 100% power in min:sec
1	0:40
2	1:10
3	2:00
4	2:53
5	4:13
6	7:10
7	2:00
8	3:08
9	N/A

Automatic Safety Cut-Off: The maximum operating time for the heater is automatically limited, depending on the power setting used in accordance with the table below.

Power Level	Maximum Operating Time in Minutes
1	520
2	402
3	318
4	260
5	212
6	170
7	139
8	110
9	90

Once the maximum operating time for any power level is exceeded, the heater is automatically switched off and the LED indicator goes blank, indicating that the control must be set to '0' power setting to reset the system.

LED Indication of Fault or Error Codes.

If the following Symbol  or letter **E** is displayed followed by a number, this indicates that the appliance has developed an internal technical fault. Switch off the appliance at the power supply. If the fault indication does not clear when mains power is restored then it cannot be rectified by the user. Switch off the power and consult your installer or qualified Service Agent.

Cooling Fan.

The induction unit has a built-in cooling fan which operates as the hob warms up. The fan will continue to operate to cool the hob after the control knob has been switched off. This is normal and after cooking, the mains power should be left connected to allow the fan to cool the internal components until the fan stops automatically.

Cooking Noises

When cooking with an induction hob, some noise may be emitted by the pan. This is normal and depends on the type of construction of the pan which may affect the noise. High power settings may produce the most noticeable noise.

	<p><u>Persons fitted with pacemakers or other electrical implants</u></p> <p>The Induction Hob complies with the applicable standards on electromagnetic interference and complies with IEC 62233:2005 Edition 1. It should not interfere with other electrical equipment providing they also comply with this standard.</p> <p>Persons who have a heart pacemaker, insulin pump, or other electrical implant should clarify with their doctor or the producer of the implant, whether those units comply with the regulations.</p>
---	--

	<p>After use</p> <ol style="list-style-type: none">1. Switch Off the induction element by its control, do not rely on the pan sensor.2. Once the appliance has cooled, turn off the power supply.
---	---

	<p>The induction appliance has an automatic overheat protection which if activated may limit functions or completely turn off the hob.</p>
---	--

CARE AND MAINTENANCE

Cleaning the Hob

Check that the appliance is cool before cleaning and switch off the electricity supply. For routine cleaning of the glass surface use a ceramic cleaning cream and clean cloth or paper towel. After cleaning, wipe dry with a dry paper towel.

If the glass surface becomes discoloured due to cooking deposits and for cleaning more stubborn stains, use a ceramic hob scraper. Foods with a high sugar content must be removed promptly to prevent them from sticking or staining the hob surface.

Clean pan supports and hob controls with warm water and detergent – they can be removed for cleaning. Replace in the same position after cleaning. When cleaning the gas burner rings it is essential to ensure that the holes do not become blocked.

Wipe all hob parts dry with a clean cloth or paper towel after cleaning.

- DO Allow the burners to heat before using for the first time, in order to expel any smells before the introduction of food.
- DO Clean the appliance before first use and regularly after use.
- DO Remove spills as promptly as possible to prevent food residue burning on the hob surface.

Gas Leaks

If a smell of gas becomes apparent, the gas supply should be turned off at the cylinder IMMEDIATELY. Extinguish naked flames including cigarettes and pipes. Do not operate electrical switches. Open all doors and windows to disperse any gas escape. Butane/Propane gas is heavier than air; any gas escaping will therefore collect at low level. The strong unpleasant smell of gas will enable the general area of the leak to be detected. Check that the gas is not escaping from an unlit appliance. Never check for leaks with a naked flame; leak investigation should be carried out using a leak detector spray.

Servicing and Maintenance

Thetford recommend an annual inspection service by an authorised service agent to maintain efficient appliance performance. In between annual service this appliance needs little maintenance other than routine cleaning.

Servicing and maintenance must only be performed by authorized and suitably qualified personnel. Refer to your local Thetford Service agent giving details of the model & Serial No. from the appliance Data Badge.

Fig 1 - Appliance Rating and Overall Dimensions

Appliance type	SERIES 981 SHB981XXZ		
Appliance overall dimensions	L 500mm	D 380mm	H 70mm
Gas Burner Ratings	MJ/hr	kW	Injector
Auxiliary Burner	3.8	1.05	0.52mm
Semi-Rapid Burner	5.9	1.64	0.67mm
Total Gas Input (Σ) MJ/hr / kW	9.70	2.69	
Induction Hob Power Consumption	230 – 240V AC 50 Hz	kW 1.4	Max Amps 6 Amps
Spark Ignition	12 Volt DC		

Gas; Universal LPG – 2.75 kPa

ELECTRICAL ENERGY CONSUMPTION MEASUREMENT AND CALCULATIONS IN ACCORDANCE WITH IEC 60350-2 2013.				
Thetford Appliance Model Identification	Cooking Zones	Type of Hob (Watts)	Diameter of Cooking Zone	Energy Consumption $EC_{\text{electric hob}}$ Wh/kg
Hybrid Hob SHB981XXZ Series	1	1.4 kW Induction Hotplate	210mm	186.7

INSTALLATION

Fig 2a Worktop Cut-Out Details SHB981XXZ Series

The worktop cut-out and fixing holes must be prepared to the dimensions shown below.

4 X Ø10mm fixing holes required

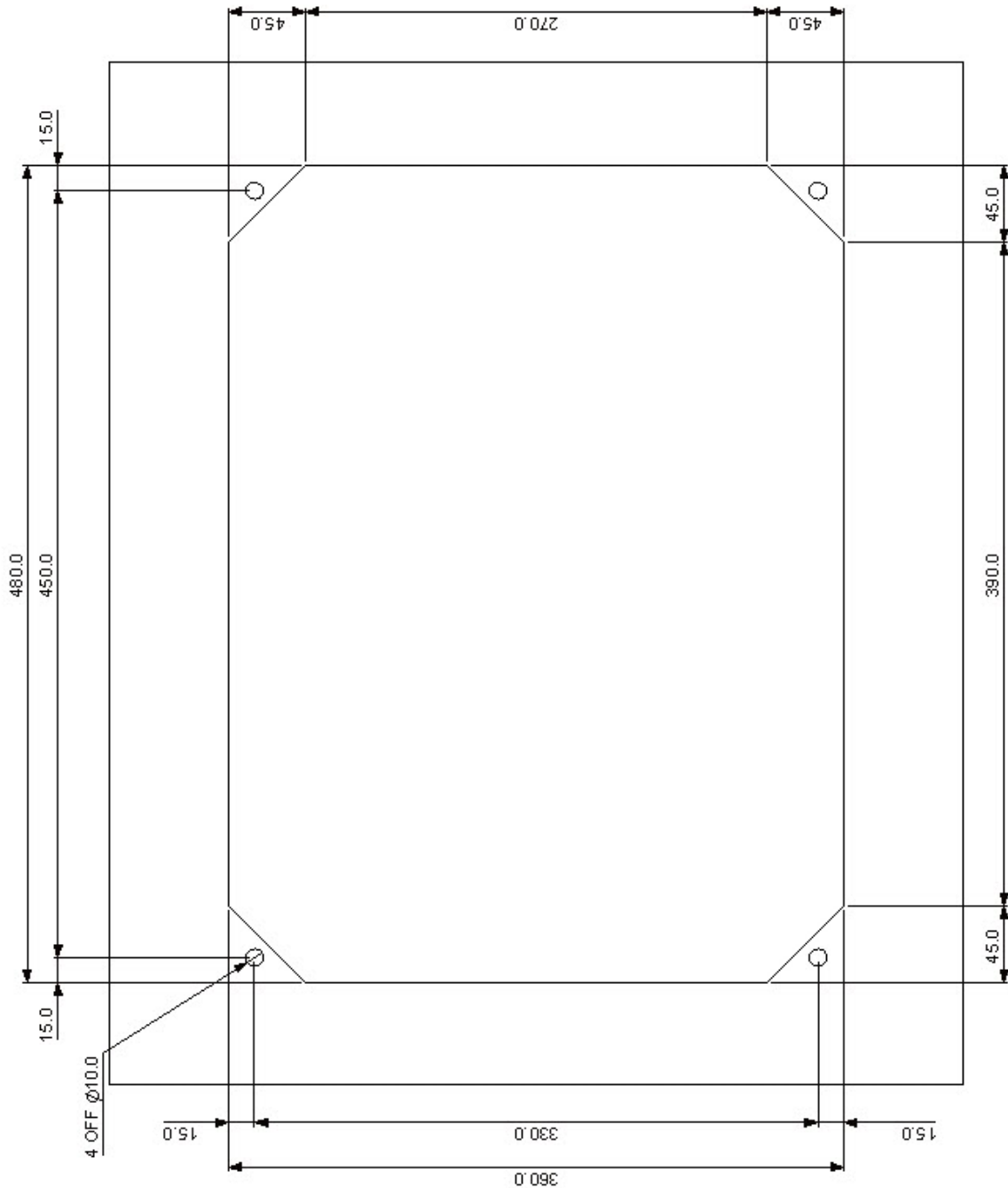

INSTALLATION

Regulations and Standards

In the interest of safety, it is a legal requirement that all gas and electrical appliances are only installed and serviced by an approved competent person, in accordance with the local and National standards in force. Failure to install the appliance correctly will invalidate any warranty or liability claims and may lead to prosecution. Particular attention shall be given to the requirements regarding ventilation in AS/NZS 5601.2 “LP Gas installations in caravans and boats for non-propulsive purposes”. Read the Installation and User Instructions and warnings before installing or using this appliance.

A gas dispersal hole is recommended beneath the appliance, venting to the outside, with minimum size $\text{Ø}12\text{mm}$, maximum $\text{Ø}25\text{mm}$, which should be screened and baffled to prevent direct draughts to the appliance, see Fig 4.

Air vents and gas dispersal holes must be kept clear.

The manufacturer cannot accept responsibility for failure in performance if the appliance is not installed in accordance with these instructions.

Fig. 3 Fixing the Hob into the Worktop Cut-out

1. Locate the four lengths of threaded stud, four washers and wing nuts.
2. Screw the four threaded studs into the threaded fixings to the underside perimeter of the hob.
3. Position appliance in worktop and attach washers & wing nuts to the threaded studs, checking the position of the hob in worktop and perimeter seal before tightening the wing nuts.

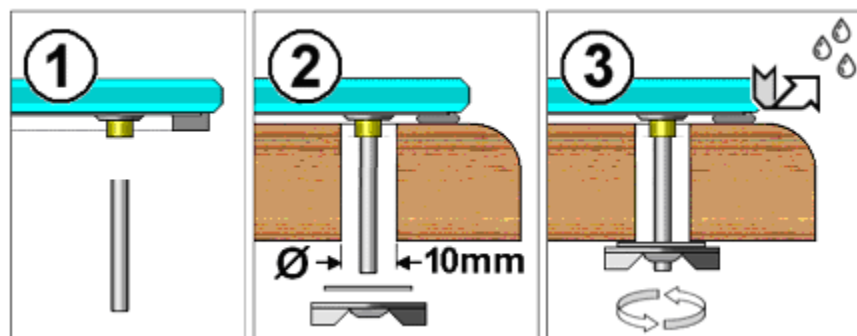



To ensure correct operation this appliance must be mounted into a worktop cut-out above a self-contained cabinet which is not connected to externally vented chambers in adjacent furniture, other than a correctly sized gas dispersal hole as described above. Any holes for cables and pipes must have the minimum clearances.

INSTALLATION

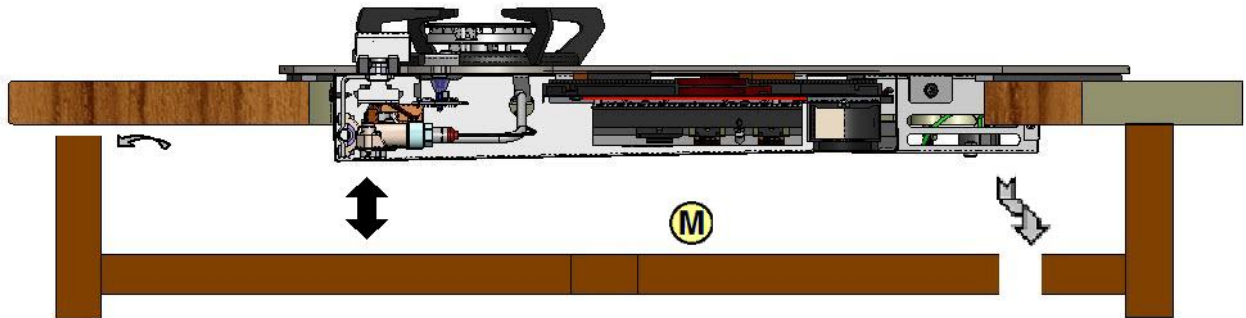
Fig 4 - Cross Section View of Appliance Mounted in a Worktop



 30mm Minimum air gap from lowest part under the hob.

 Non – combustible material.

 Vent – 8mm x 100mm minimum.

 Gas dispersal hole (Ø12mm Minimum, Ø25mm Maximum).

Ventilation

This appliance is suitable for installation into Holiday Homes, Touring Caravans and Boats. In all cases the national standards with regard to ventilation for the particular vehicle into which the appliance is to be installed must be adhered to. AS/NZS 5601.2 “LP Gas installations in caravans and boats for non-propulsive purposes” specifies appliances be installed in accordance with the manufacturer’s instructions.

Location of Appliance

This appliance may be installed in a kitchen/kitchen diner but NOT in a room containing a bath or a shower. LP gas appliances must not be fitted below ground level, e.g. not in a basement

INSTALLATION

Position

A cutout should be prepared as shown in the enclosed diagrams – see Fig. 2 and Fig.2a for model cutout details. We recommend the underside of the hob be shielded, particularly if this area is to be used for storage or the installation of another appliance. The shield should be fabricated from non-combustible material, but if the enclosure is manufactured from combustible material there should be a minimum air gap of 30mm between lowest part under hob and the shield, see Fig 4.

A horizontal distance of 200mm must exist between the edge of the burners and combustible material unless protected by a layer of non-combustible material. A non-combustible heat shield (splash back) should be fitted onto the walls directly behind the appliance.

Fig 5 Minimum Installation Clearances

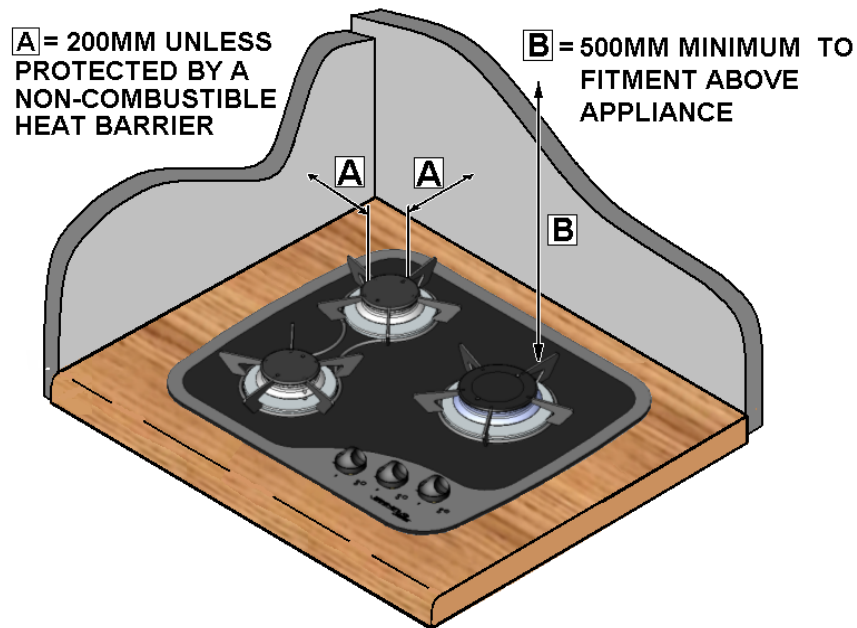

All combustible materials such as curtains and shelves must be kept well clear of the appliance. Any fitments such as a cupboard above the appliance must have a minimum vertical clearance of 500mm between the fitment and the top of the pan support – see Fig. 5.

The appliance should be fixed in place using the fixing screws provided – see Fig. 4 for details. Make sure the appliance is fully home and level in the worktop before fixing securely in place.

INSTALLATION

This appliance must be positioned free from draughts, which may affect the combustion, and in a manner that will prevent the accumulation of unburnt gas. When in use ensure that air vents are not inadvertently blocked or shut off.

If other appliance/s are located below the hob we recommend conducting a temperature verification test to confirm any rise in temperature of the cabinet materials are within allowable limits and meet requirements specified in AS 4551-2008.

The performance of this appliance meets the requirements of AS 4551-2008, which specifies a maximum allowable temperature rise of the furniture into which the appliance is installed of 65°C above the ambient temperature. It is important the installer verifies the furniture construction material and that it is suitable for the application - i.e. plastic materials used in the construction may have a softening point lower than the maximum allowable temperature rise specified in the European Standard.

We recommend the installation follows the minimum dimensions shown in this manual as any deviation could result in excessive temperature rise. If minimum dimensions must be reduced, due to design constraints, a temperature rise test of all furniture fitted around the unit **MUST** be performed. The design is deemed permissible providing the results of this test comply with the allowable temperature rise specified above and with all standards in force. In addition comply with all requirements detailed within the furniture manufacturer's material specification. Where minimum dimensions are reduced we recommend protecting with non-combustible material.

Gas Connection

A 1/4" BSP taper gas inlet connection and pressure test point is provided underneath the appliance – see page 6. It is recommended that the appliance is connected by steel or copper tubing, a rubber or hose connection should not be used. The gas inlet must be accessible with the appliance installed in accordance with AS/NZS 5601.2. After connection the appliance must be tested for gas soundness.

This appliance is suitable for use with UNIVERSAL LPG ONLY at 2.75 kPa pressure. It is important that the regulator should be set to the correct pressure for the type of gas being used. Excessive pressure must not be permitted. If the flame on any burner should show a tendency to lift, it is possible that the line pressure is too great. Should there be excessive yellow tips (resulting in sooting), then it is possible that the line pressure is too low. In either case the burners should not be used until the line pressure has been confirmed. The burners on this appliance have fixed aeration and no adjustment is necessary.

INSTALLATION

Electrical Connection

Models fitted with power cord only (See Fig.6 Mains Wiring Diagram).

These appliances are supplied with a double insulated cord, type 227 IEC 53, HO5V V-F, which is suitable for use up to 10 amps. This should be connected to a suitable double pole switched mains supply, with 3mm minimum contact separation at all poles. Ensure that all electrical cables and wires are routed well clear of any heat source, including this appliance. Do not allow the cord to hang loose into the lower compartment. The switch must be accessible after installation.

Models fitted with plug and power cord

These appliances are supplied with a plug attached to the end of the power cord, for connection to a switched wall mounted socket. After connection ensure the power cord and any other electrical wires are routed well clear of any heat source, including this appliance. Do not allow the cord to hang loose into the lower compartment. The switched socket must be accessible after installation.

Induction Functions

The induction heater has a rotary control knob with 9 positions, from 0 = off to 9 = high setting. High setting is automatically limited to a maximum of 90 minutes continuous use and there is an LED indication of power on and residual heat. Pan detection for induction heater – after 30 seconds without a pan or with an unsuitable type of pan, the heater switches off automatically and will not reset without the control switch first being returned to zero.

After connection, test for electrical safety. Refer to the User Instructions and warnings enclosed and test all induction heating functions described.

Electrical Connection – 12V DC Spark Ignition

The spark ignition generator must only be connected to a suitable 12V DC supply, e.g 12V vehicle battery. Transformers if used must be of the fixed voltage type. Use sheathed spade connectors to connect the spark generator to the power supply.

After installation and connection this appliance must be tested for gas soundness, ignition of all burners including simultaneous ignition and electrical safety. The gas supply pressure to which this appliance is connected must not rise or fall by more than 2.5 mbar from the stated nominal, when all appliances connected to the supply are operated simultaneously.

In the event that this appliance cannot be adjusted to perform correctly and for any service assistance, please contact your authorised Thetford Service Agent giving details of the model and serial number from the data badge on the underside of the appliance, plus the date of purchase.

INSTALLATION

Fault Indication

Error or Fault codes in the Induction system are displayed on the LED display by flashing 'E' or 'F' symbol, followed by a number. In the event that the induction unit detects an error or internal fault other than 'H' residual heat, contact the Thetford Service Centre.

SERVICING

Do not modify this appliance. All servicing must be carried out by an approved competent person. Before any service work is started the appliance should have been left to cool and be disconnected from both the gas and electrical supplies. After any service or maintenance work the appliance must be checked for both electrical safety and gas soundness.

Thetford Ltd does not accept responsibility for loss or injury caused directly or indirectly by incorrect use of this appliance. In accordance with our policy of product development we reserve the right to amend designs and specifications without prior notice.

If servicing requires removal of the appliance.

To remove the hob

- (1) Isolate the mains electricity supply and disconnect appliance from the supply.
- (2) Turn off the gas and disconnect the appliance from the gas supply.
- (3) Disconnect the appliance from the 12V DC electricity supply.
- (3) Release and remove the appliance clamping screws.
- (4) Carefully lift out the appliance from the worktop and place on a suitably protected surface.

Hob burner gas valve removal/replacement

Shut off the gas supply and disconnect the gas and electrical supplies from the unit. Remove the hob from the worktop as above.

Remove the appropriate control knob by pulling up on the knob.

From underside of hob, unclip and remove the spark generator from the side of the rear cover. Remove the 5 fixing screws and lift the rear cover aside. Carefully disconnect the appropriate thermocouple at the gas valve. Unscrew the appropriate gas supply pipe nut.

Remove the appropriate gas valve clamp by unscrewing the two screws.

Withdraw the gas valve from the underside of the hob. The circular ignition switch actuator is a spilt collet which can be removed from the tap spindle and the tap may then be detached from the appliance.

Replace the valve and gasket. Refit using the reverse of the above procedure.

SERVICING

Hob burner injector removal/replacement.

Unclip the enameled pan rest from the stainless steel burner boss and lift off. Remove the screw in the burner cap and lift off the burner cap and skirt / flame spreader. With a 7mm A/F socket, unscrew the injector from the bottom of the burner mixing tube. Replace/refit using the reverse of the above procedure.

Thermocouple removal/replacement

Disconnect gas and electrical supplies and remove the rear cover as above. From the underside of the hob, carefully disconnect the appropriate thermocouple at the gas valve. Remove the spring clip retaining the thermocouple at the burner. Remove the thermocouple. Replace/refit using reverse of the above procedure.

Burner cup removal / replacement

Spark ignition wire / electrode removal.

Disconnect from gas and electrical supplies and remove the appliance from worktop as above. Disconnect the 12v power wires from the spark generator. Pull off the fixing clip on the burner and remove electrode from the burner cup. Trace the electrode wire back to the generator and pull off the connector. Replace/refit using reverse procedure.

12v Spark Generator replacement

Located on the underside of appliance. Remove all electrode wires. Unscrew and/or unclip the spark generator and lift off the unit. Replace/refit using reverse procedure.

Induction Components

A Thetford approved Service Agent must be consulted if any induction components require removal or replacement. The induction control circuits and coils are not user serviceable and are sensitive to electrostatic discharge. Electrostatic Discharge (ESD) protection must be provided before touching any electronic components if removing the rear cover, to prevent damage to the induction control circuits.

FAULT DIAGNOSIS

GAS OPERATION		
FAULT OBSERVED	CAUSE	SOLUTION
Burner will not adjust (continuously on low or high flame setting)	Gas pressure Blocked jet Control tap fault	Check gas pressure correct Clear blockage from jet and check the jet size Inspect / test the control tap
Burner causes soot deposits	Gas pressure	Check and adjust the gas pressure. Low pressure is usually the cause of soot deposits
Burner flame lift	Gas Pressure	Check and adjust the gas pressure. High pressure may cause the flames to lift
Burner – no Spark Ignition	Power supply Poor connection Spark generator	Check power supply Check all connections Test spark generator and check for earth leakage due to damaged wire
Burner will not remain lit	Thermocouple failure. Blocked jet	Test & replace thermocouple if required Check thermocouple in flame path Clear jet blockage
INDUCTION OPERATION		
FAULT OBSERVED	CAUSE	SOLUTION
LED Display shows <u>U</u>	No pan detected or pan not suitable for induction heating	Use a suitable pan placed centrally over the induction heating zone.
LED Display shows E or  on start up	Internal fault detected.	Disconnect electric supply and refer to Thetford approved Service Agent.
LED Display shows 'H' after use	Residual heat detected, glass surface is still hot.	This is normal, allow the appliance to cool after use.

For assistance with service, please contact your authorised local Service Agent giving details of the model and serial number on the data badge as shown below, plus date of purchase.



Model Name & Series Number				
G30	CAT I ₃ + (28/30-37) BUTANE 28-30mbar	CAT I ₃ B/P(30) BUTANE 30mbar	THETFORD	
G31	PROPANE 37mbar	PROPANE 30mbar		
	Power kW (g/hr)	Model Number	Spark Ignition	
	Pin Number	Serial Number	Voltage ~ 50Hz	
Country Codes 1		Country Codes 2	QC Pass	Order No

Fig 6. Mains Wiring Diagram

